

This information provided by:

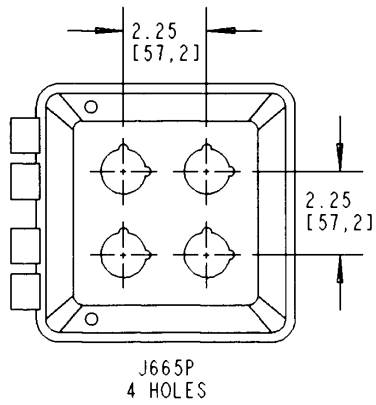

Gross Automation
www.grossautomation.com

Call Toll Free:
800-349-5827



J665P
4 HOLES

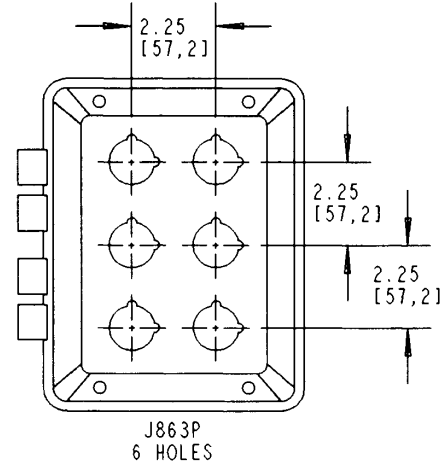

J863P
6 HOLES

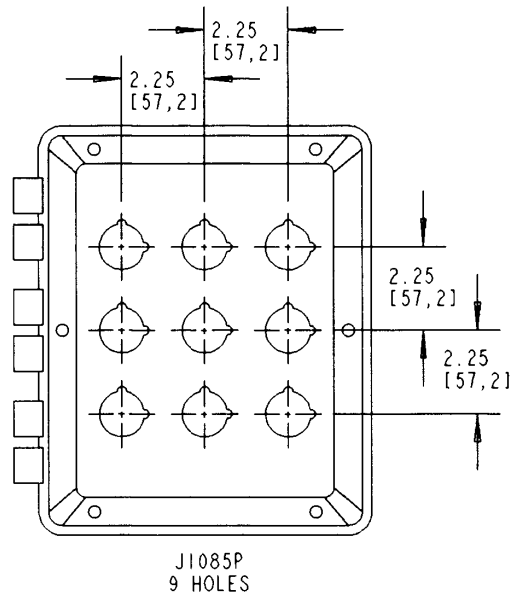

J1085P
9 HOLES

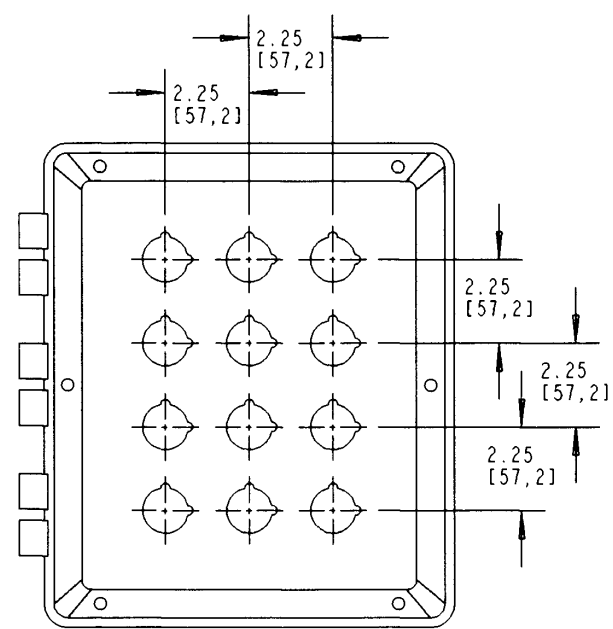

J12106P
12 HOLES

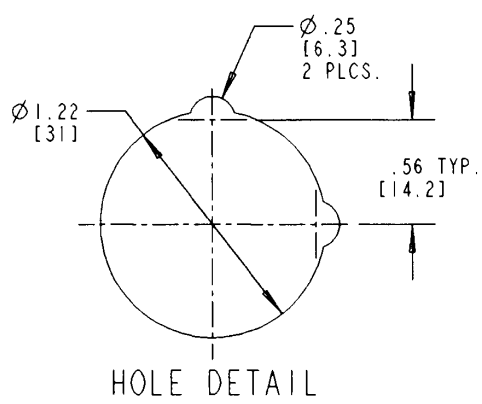

HOLE DETAIL

NOTES:
 1. ALL DIMENSIONS ARE IN INCH/[MILLIMETERS].
 2. SEE DRAWING AC01610 FOR ENCLOSURE DIMENSIONS.

TITLE PUSH BUTTON ENCLOSURES		DRN DPR	DATE 1-14-04	PART NO: AS NOTED
LAMSON & SESSIONS	ALL DRAWINGS ARE THE PROPERTY OF LAMSON & SESSIONS AND SHALL NOT BE REPRODUCED IN ANY FORM WITHOUT LAMSON & SESSIONS' APPROVAL AND ARE TO BE PROMPTLY RETURNED UPON REQUEST.	APP. <i>[Signature]</i>	DATE 1/14/04	DRAWING NO: AC04490
				SHT. 1 OF 2
				REV.

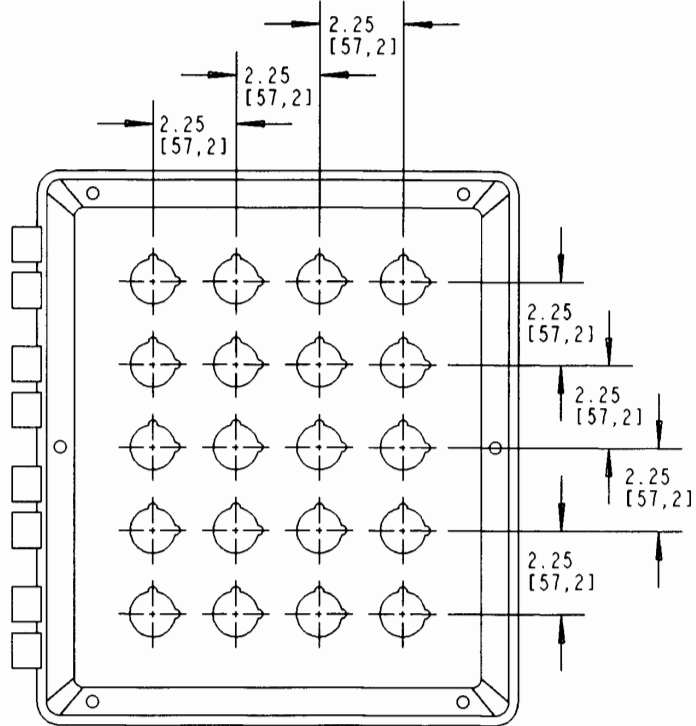

J14126P
20 HOLES

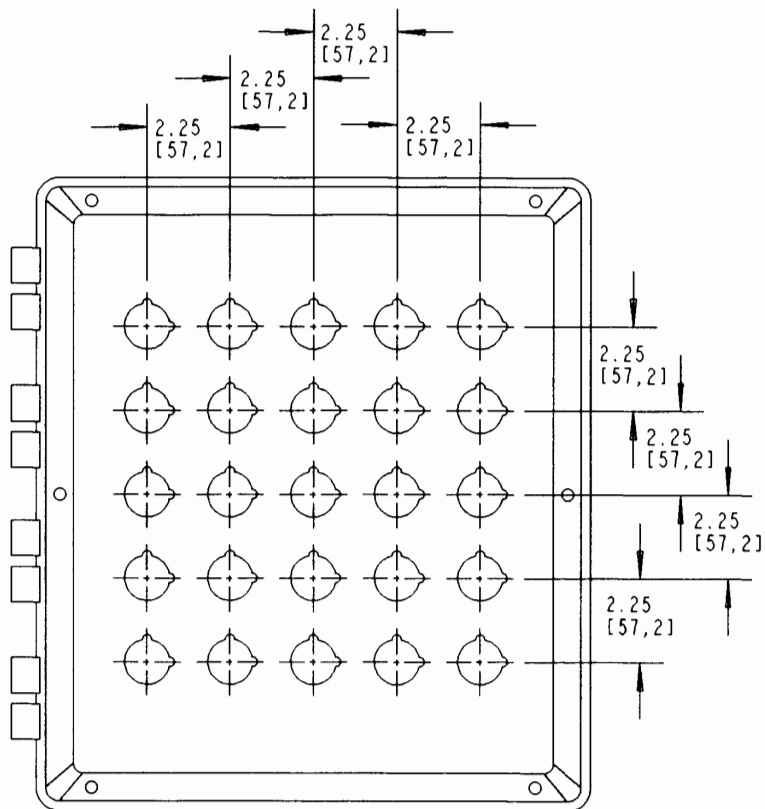

J16147P
25 HOLES

NOTES:

1. ALL DIMENSIONS ARE IN INCH/[MILLIMETERS].
2. SEE DRAWING AC01610 FOR ENCLOSURE DIMENSIONS.

TITLE PUSH BUTTON ENCLOSURES		DRN DPR	DATE 1-14-04	PART NO: AS NOTED
LAMSON & SESSIONS	ALL DRAWINGS ARE THE PROPERTY OF LAMSON & SESSIONS AND SHALL NOT BE REPRODUCED IN ANY FORM WITHOUT LAMSON & SESSIONS' APPROVAL AND ARE TO BE PROMPTLY RETURNED UPON REQUEST.	APP.	DATE 1/14/04	DRAWING NO: AC04490
				SHT. 2 OF 2
				REV.