

This information provided by:

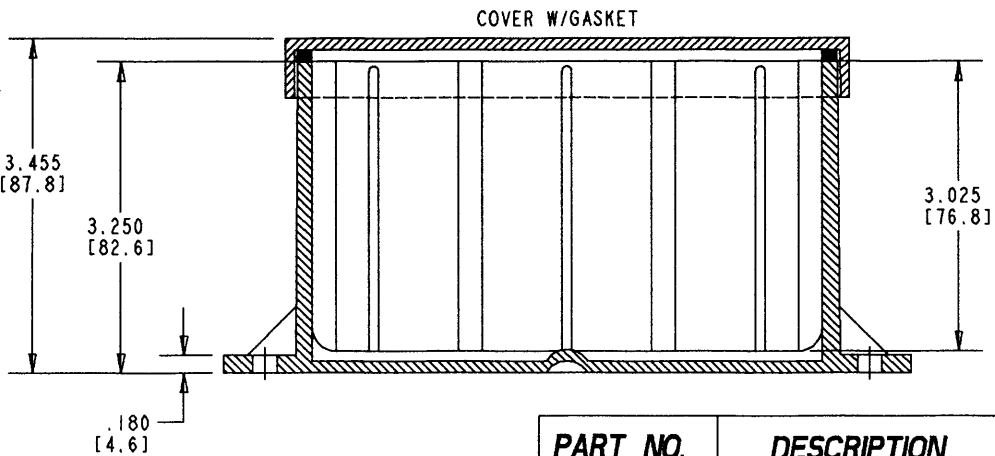

Gross Automation
www.grossautomation.com

Call Toll Free:
800-349-5827

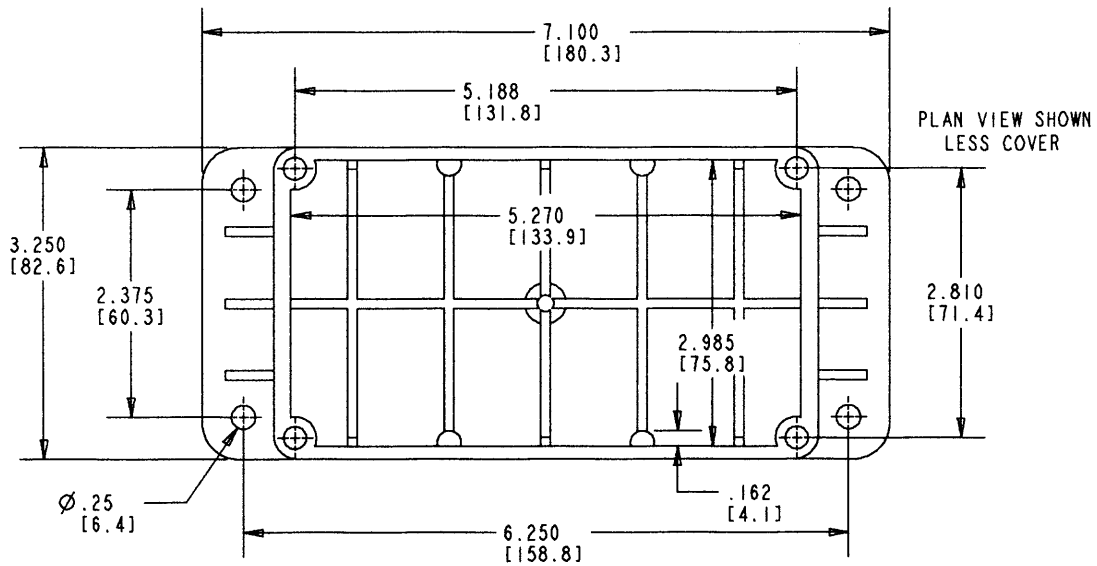
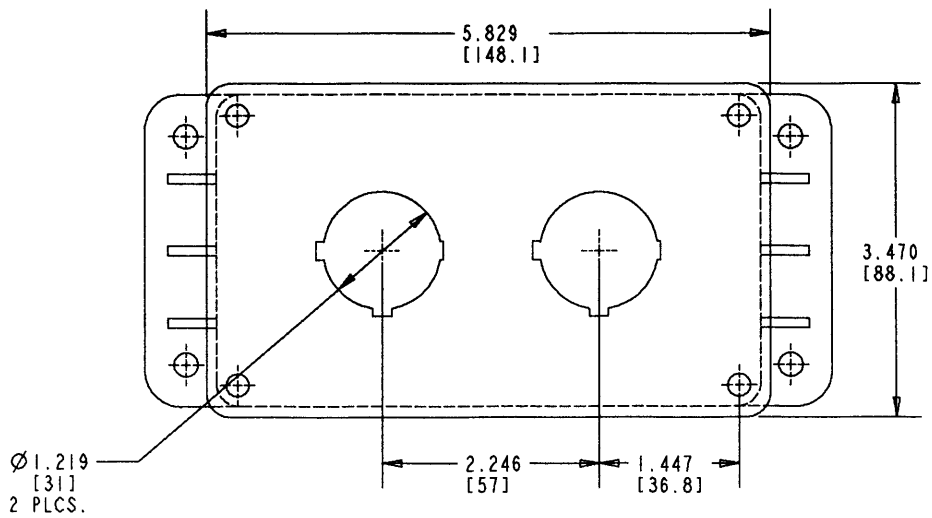

PART NO.	DESCRIPTION
CP200N	TWO BUTTON
CP200NB	BLANK COVER

DIMENSIONS ARE IN INCHES/MILLIMETERS

TITLE PUSH BUTTON ENCLOSURE		DRN DPR	DATE 1-27-94	PART NO.: SEE CHART	
LAMSON & SESSIONS		ALL DRAWINGS ARE THE PROPERTY OF LAMSON & SESSIONS AND SHALL NOT BE REPRODUCED IN ANY FORM WITHOUT LAMSON & SESSIONS' APPROVAL AND ARE TO BE PROMPTLY RETURNED UPON REQUEST.		APP. AG	DATE 3-8-98
				DRAWING NO.: AC01671	REV. A
				SHT. 1 OF 2	

P/N PX0007

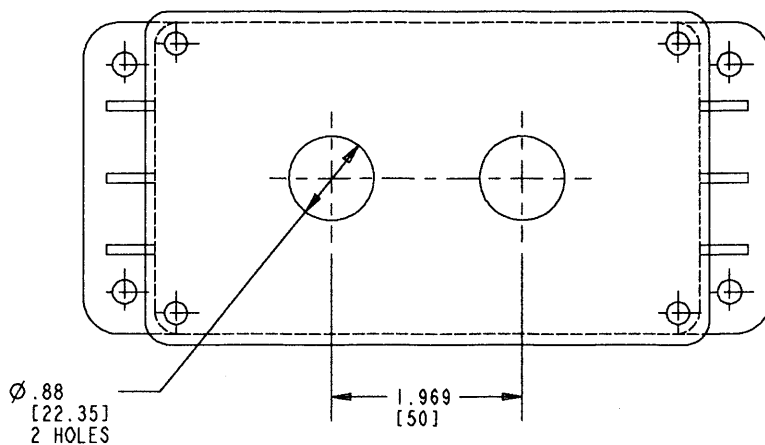

P/N PX0009

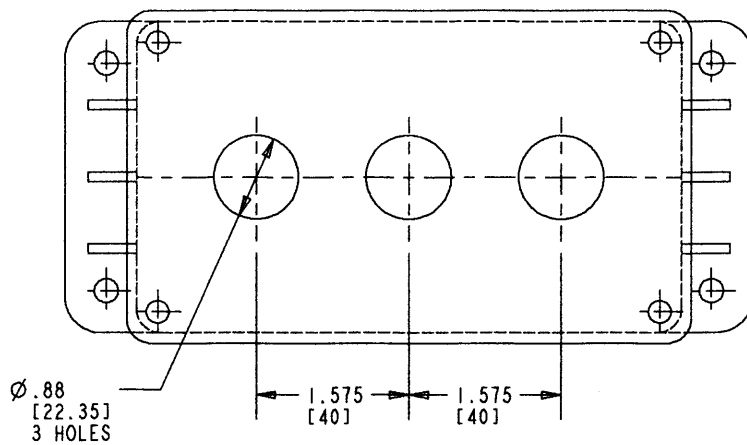

TITLE PUSH BUTTON ENCLOSURE		DRN DPR	DATE 10-3-98	PART NO.: SEE ABOVE	
LAMSON & SESSIONS	ALL DRAWINGS ARE THE PROPERTY OF LAMSON & SESSIONS AND SHALL NOT BE REPRODUCED IN ANY FORM WITHOUT LAMSON & SESSIONS' APPROVAL AND ARE TO BE PROMPTLY RETURNED UPON REQUEST.	APP.	DATE	DRAWING NO.: AC01671	REV. A
					SHT. 2 OF 2