

This information provided by:

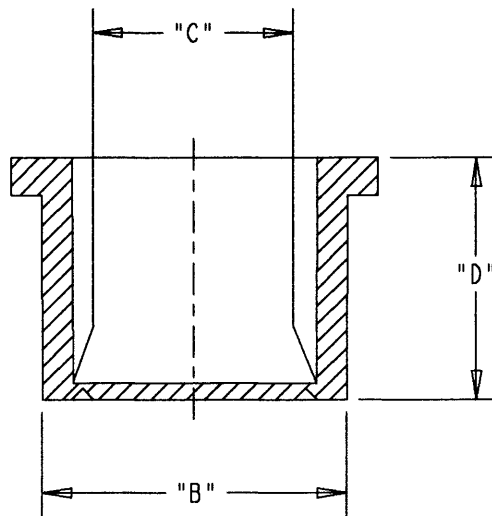

Gross Automation
www.grossautomation.com

Call Toll Free:
800-349-5827

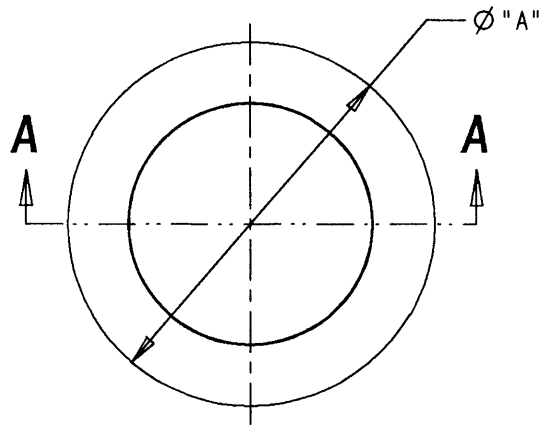

SECTION A-A

PART NO.	SIZE	"A"	"B"	"C"	"D"
E971C	3/4" X 1/2" [19.05x12.7]	1.267 [32.18]	1.050 [26.67]	.840 [21.34]	.842 [21.39]
E971D	1" X 3/4" [25.4x19.05]	1.505 [38.22]	1.311 [33.29]	1.043 [26.49]	.955 [24.25]

DIMENSIONS ARE SHOWN IN INCHES AND MILLIMETERS.

TITLE REDUCER PLUG		DRN PMW	DATE 3-31-97	PART NO: SEE TABLE
LAMSON & SESSIONS	ALL DRAWINGS ARE THE PROPERTY OF LAMSON & SESSIONS AND SHALL NOT BE REPRODUCED IN ANY FORM WITHOUT LAMSON & SESSIONS' APPROVAL AND ARE TO BE PROMPTLY RETURNED UPON REQUEST.	APP. JM	DATE 4-7-97	DRAWING NO: AC03061
		REV. A		