

This information provided by:



Gross Automation  
[www.grossautomation.com](http://www.grossautomation.com)

Call Toll Free:  
**800-349-5827**

SIZE	BACK PANEL	
	G	H
JP64	4.88 (124.0)	2.88 (73.2)
JP66	4.88 (124.0)	4.88 (124.0)
JP86	6.75 (171.5)	4.88 (124.0)
JP88	6.75 (171.5)	6.88 (174.8)
JP108	8.75 (222.3)	6.88 (174.8)
JP1010	8.75 (222.3)	8.88 (225.6)
JP1210	10.75 (273.1)	8.88 (225.6)
JP1212	10.75 (273.1)	10.88 (276.4)
JP1412	12.75 (323.9)	10.88 (276.4)
JP1614	14.75 (374.6)	12.88 (327.2)

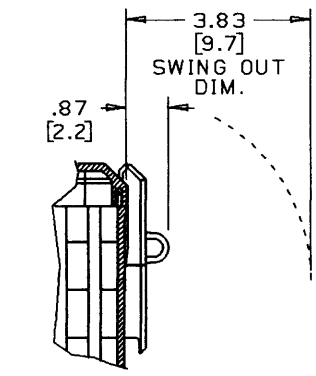
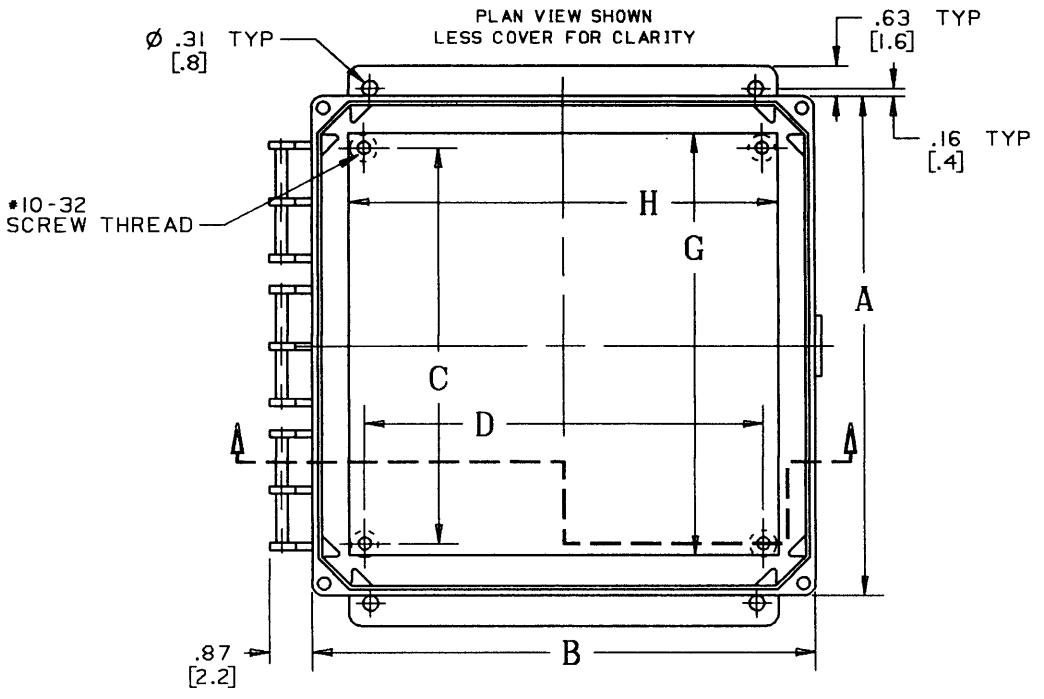

PLASTIC LATCH  
(ORDER SEPARATELY)  
P/N NPLIS

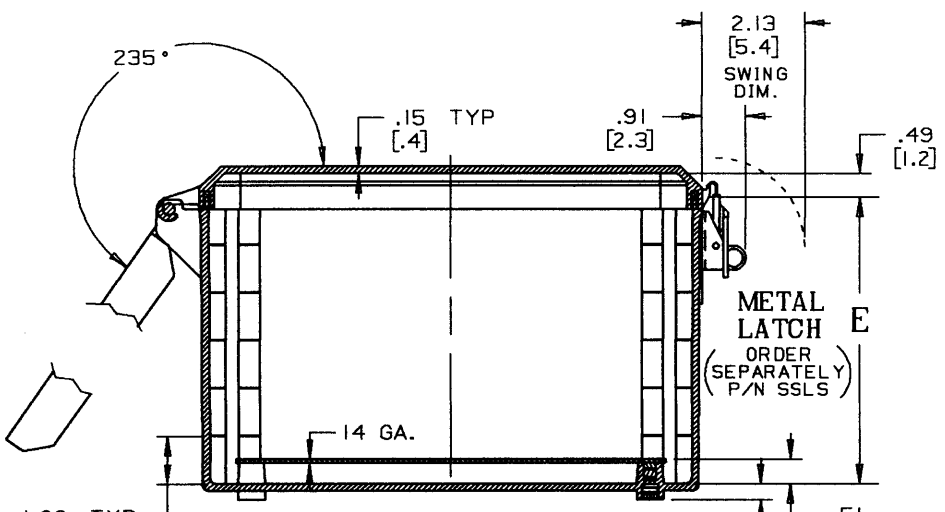

METAL LATCH  
(ORDER SEPARATELY)  
P/N SSLS

LEGEND EXAMPLE

N C 644  
ENCLOSURE SIZE  
COVER TYPE  
M=CLEAR COVER W/LATCH  
C=CLEAR COVER W/O LATCH  
L=OPAQUE COVER W/LATCH  
J=OPAQUE COVER W/O LATCH  
NEMA TYPE 1-3-3S-12-4/4X

NOTES:  
1. ALL DIMENSIONS ARE INCHES AND (MILLIMETERS).

SIZE	A	B	C	D	E	F
-- 644	6.42 (163.1)	4.41 (112.0)	4.25 (108.0)	2.25 (57.2)	4.00 (101.6)	2.00 (50.8)
-- 664	6.42 (163.1)	6.42 (163.1)	4.25 (108.0)	4.25 (108.0)	4.00 (101.6)	4.00 (101.6)
-- 864	8.42 (213.9)	6.42 (163.1)	6.25 (158.8)	4.25 (108.0)	4.00 (101.6)	4.00 (101.6)
-- 884	8.42 (213.9)	8.42 (213.9)	6.25 (158.8)	6.25 (158.8)	4.00 (101.6)	6.00 (152.4)
-- 1084	10.42 (264.7)	8.42 (213.9)	8.25 (209.6)	6.25 (158.8)	4.00 (101.6)	6.00 (152.4)

SIZE	A	B	C	D	E	F
-- 1086	10.42 (264.7)	8.42 (213.9)	8.25 (209.6)	6.25 (158.8)	6.00 (152.4)	6.00 (152.4)
-- 10106	10.42 (264.7)	10.42 (264.7)	8.25 (209.6)	8.25 (209.6)	6.00 (152.4)	8.00 (203.2)
-- 12106	12.42 (315.5)	10.42 (264.7)	10.25 (260.4)	8.25 (209.6)	6.00 (152.4)	8.00 (203.2)
-- 12126	12.42 (315.5)	12.42 (315.5)	10.25 (260.4)	10.25 (260.4)	6.00 (152.4)	10.00 (254.0)
-- 14126	14.42 (366.3)	12.42 (315.5)	12.25 (311.2)	10.25 (260.4)	6.00 (152.4)	10.00 (254.0)
-- 16146	16.42 (417.1)	14.42 (366.3)	14.25 (362.0)	12.25 (311.2)	6.00 (152.4)	12.00 (304.8)

TITLE: EXTERNAL HINGE ENCLOSURES		DRN. RG	DATE 12/6/94	PART NO: NJ/NC SERIES
LAMSON & SESSIONS	ALL DRAWINGS ARE THE PROPERTY OF LAMSON & SESSIONS AND SHALL NOT BE REPRODUCED IN ANY FORM WITHOUT LAMSON & SESSIONS' APPROVAL AND ARE TO BE PROMPTLY RETURNED UPON REQUEST.	APP. DK	DATE 6/24/97	DRAWING NO: AC02093
				REV. B